



PSN 6 Pellet stove
Assembly and exploitation manual



The present stove is designed and manufactured according to
Standards: BNS (Bulgarian National Standard) EN 14785-2006

Mareli Systems

Observing the prescriptions of the present manual is in the user's favour and is one of the warranty conditions. Compliance with this instruction is in the interest of the consumer and one of the warranty terms.

INSTRUCTIONS FOR SECURITY:

- This appliance is not intended for use by people (including children) with limited physical, sensory or mental abilities or lack of experience and knowledge. The installation must be performed by a qualified expert in the field of heating installations or authorized by "Mareli Systems' service. The place and way of connecting the stove should be selected carefully in accord with the safety instructions. Install away from flammable objects!
 - Before starting any operation, the user must read and fully understand the contents of this instruction manual. Incorrect setup may cause hazardous conditions and / or incorrect function of the stove;
 - Do not wash the stove with water. Water can get inside the fireplace and damage the electronics and cause an electric shock;
 - Do not put clothes to dry on the stove. Any clothes hangers and other objects must be located within a reasonable distance from the fireplace. Fire hazard;
 - The user is fully responsible for the proper use of the product which exempts the company from liability of any users errors or misbehaviour or omissions;
 - Any intervention or replacement that is made by unauthorized people or using non original spare parts for the product can be risky for the user and release the company from all liability;
 - Most surfaces of the stove are extremely hot (the door handle, glass, flue pipe, etc.). Avoid contact with these parts before assuring yourself that you use temperature resistant gloves as well as suitable temperature resistant instruments;
 - Under no circumstances should the fire be ignited with the door open or broken glass;
 - The product must be electrically connected to a system equipped with an effective earth conductor. (Must be grounded);
 - Turn off the stove in case of failure or malfunction;
 - All unburned pellets in the burner after each unsuccessful attempt ignition must be removed before a new ignition;
 - When installing the product all fire safety requirements must be respected
- If there is a fire in the flue pipe, extinguish the stove, disconnect the power cord and never open the door. Call competent authorized service technicians;
- Do not light the stove with flammable materials if the ignition system failed;
 - Periodically check and clean the smoke outlet ducts of the stove (connection to the flue pipe);
 - Pellet stove is not a cooker;
 - Always keep the cover closed;

SAFE DISTANCES:

When installing the product a safe distance of at least 600 mm must be respected. This distance applies to the product located near materials of B or C flammability level. The safe distance is doubled if the product is close to materials of C3 combustion level.

1. PURPOSE

The stove is purposed to heat domestic and public premises by the means of pellets. The stove is designed and manufactured to work with A-class pellets only (DIN plus 51731) with the following characteristics:

- Material 100% pure conifer or broad-leaf wood;
- Diameter $\Phi 6/8$ mm;
- Length 20-30mm;
- Calorie capacity 5.2 kW/kg;
- Ash content < 8%;



The use of pellets with characteristics different from the recommended may result in power decrease, unstable and inconsistent work of the stove.

What are the pellets.

The pellets are produced by compressed wood-en waste left from the production of various furniture, sawmills and others. This type of fuel is environmentally friendly because in the production process no agglutinate agents (glues, resins and others) are added. Actually, the integrity of the pellets is guaranteed by the lignite – a natural ingredient contained in the wood itself. While the wood has a calorie capacity of 4.4 kW/kg (15% humidity at 18 months drying), the pellets have 5.2 kW/kg.



Info: To ensure the proper work of the stove the pellets must be stored in a dry place!

Recharging of pellets can be done during work, with the following sequence:

1. Open the bunker (located at the top rear of the product);
2. Fill the hopper, using non-combustible container;
3. Close the lid of the bunker;

Attention!!! Use gloves! Beware of hot surfaces!

2. TECHNICAL DATA

Maximum output	KW	6
Heated area	m ³	160
Height H	mm	890
Width W	mm	520
Depth D	mm	510
Pellet bunker volume	kg	15
Fresh air pipe	φ mm	48
Exhaust gas pipe	φ mm	80
Weight	kg	97
Fuel type		Pellets Ø6-Ø8
The chimney draft	Pa	12
Electrical consumption	V/Hz	60/350
Electrical supply	V/Hz	230/50
Fuel consumption	kg/h	0,3-1,2
Energy conversion efficiency	%	>91
Co Emissions	Mg/m3	<300
Temperature of the flue gas	C	140

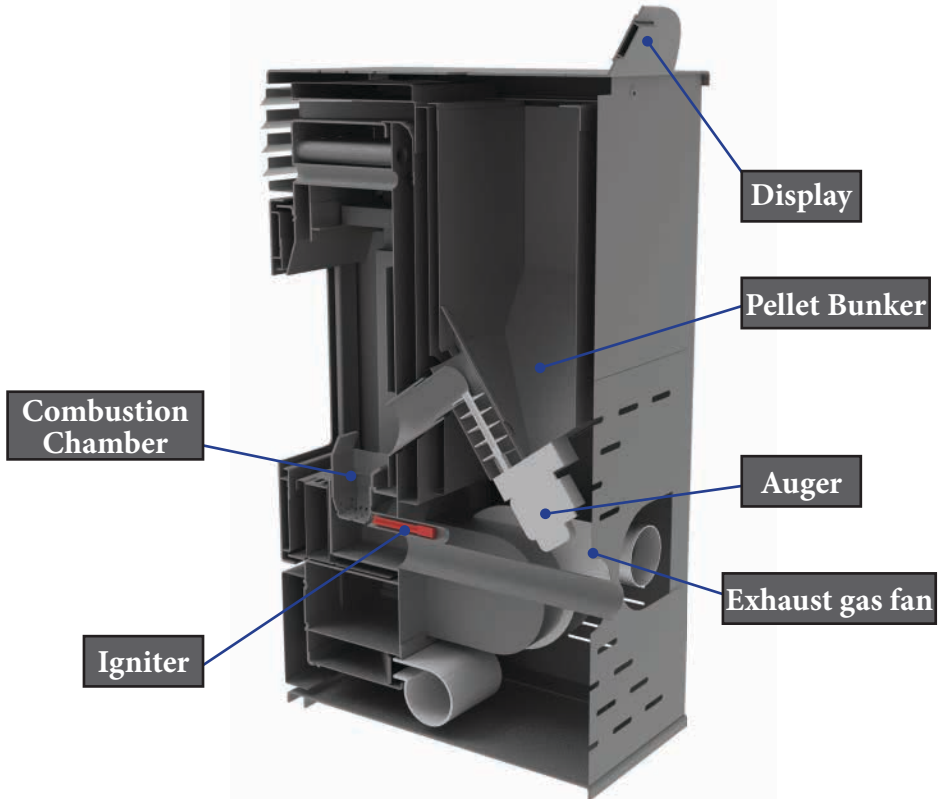

3. ASSEMBLY

3.1 General conditions.

All national, regional and European requirements for safe operation of the appliance must be respected during installation and operation.

Prior to installation, load capacity of the place where the stove will be intended must be ensured. The weight of the stove is specified in the technical data table.

To ensure the correct and safe operation of the stove, the following conditions must be met:

The installation of the stove and its accessories must be carried out by authorized persons.

The floor where the stove is installed should be flat and horizontal, made of fire-resistant materials at least 1500 mm in front of the fireplace and not less than 400 mm on both sides and at the back of the wall.

Minimum distances from the wall to the stove should be at least 400 mm. The minimum space in front of the fireplace should be 1500 mm. The minimal distance of the stove from combustion materials should be no less than 1500 mm.

The door of the fireplace should be closed tightly during the work process. Opening it during work is absolutely forbidden.

When installing the stove, the connections between the individual pipes and the chimney rooftop must be dense.

When the fire is first ignited, a smell occurs as a result of the paint being heated.

The fireplace is painted with heat-resistant paint, which achieves its ultimate resistance after repeated use of the stove. THEREFORE KEEP OUTSIDE INTERACTIONS WITH THE COATING TO A MINIMUM in order not to damage it.

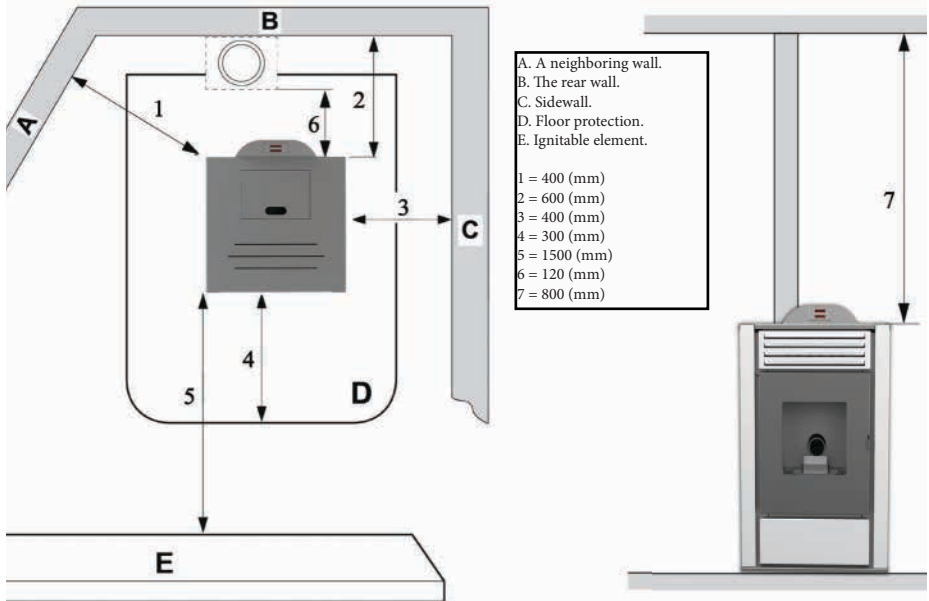

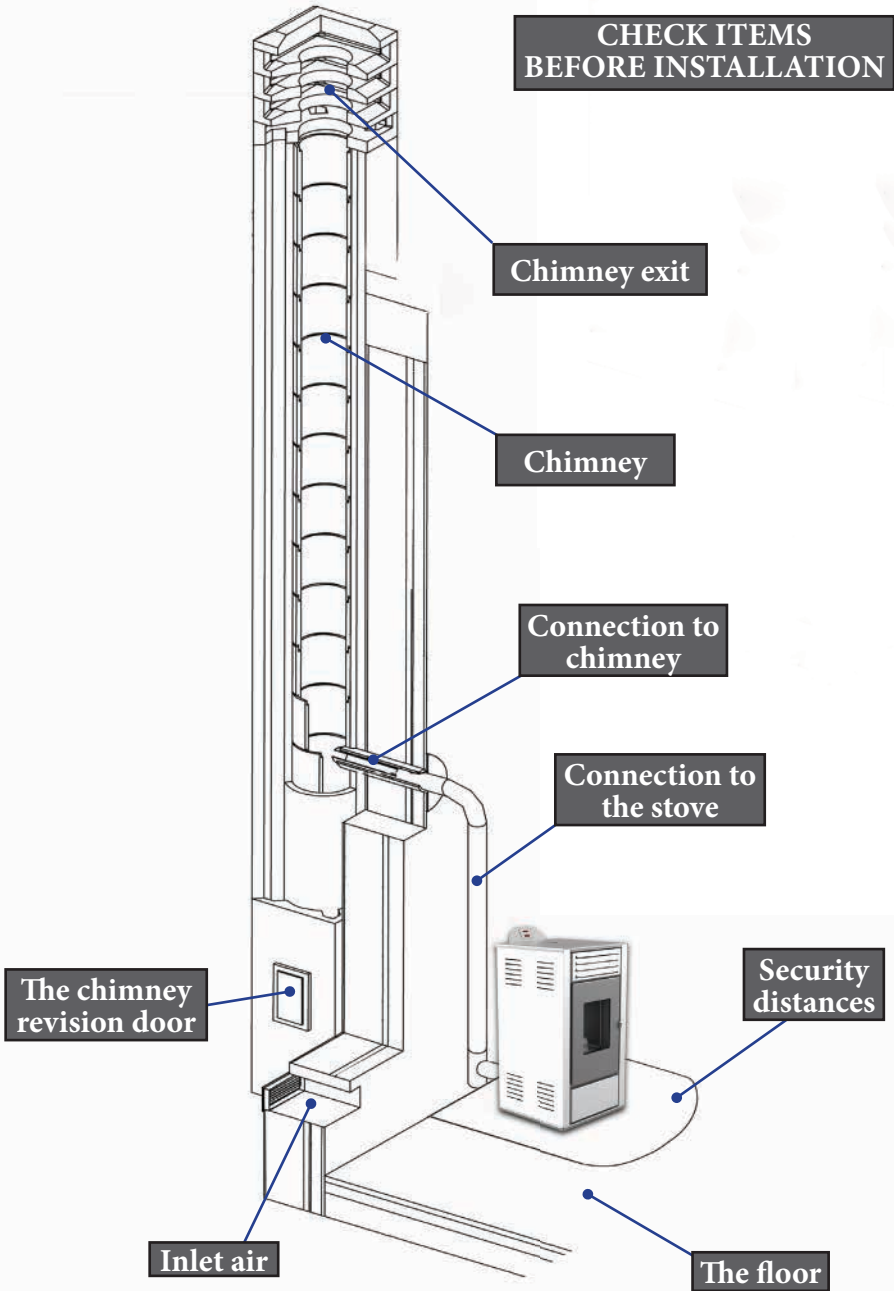

3.3 Assembly of the duct components.

Duct components and pipes

For the assembly of the duct pipes the use of non-flammable materials, resistant to the flammable products and condensation is obligatory. The assembly must be performed in such a manner so it guarantees the airtight sealing and prevents condensation. If possible, avoid adding horizontal sections. Direction shift is done by using knee joints with a max angle of 45° . For heating devices equipped with a smoke ventilator, i.e all of the "MARELI" stoves, the following instructions must be observed:

- Horizontal sections must have a minimum incline of 3° upwards;
- The length of the horizontal sections must be as short as possible, but without exceeding 3 m;
- More than four direction shifts are forbidden, including the cases where a T-shaped element is used;
- The duct components must be airtight and to be insulated if extending outside the premises in which the fireplace is installed;
- The duct components must allow a soot cleaning;
- The duct components must have a constant section. A section change is allowed only in the chimney joint;

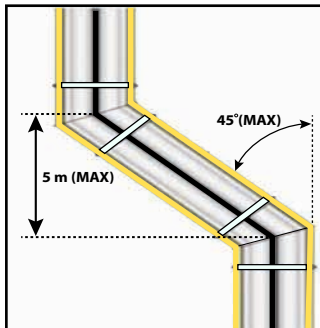
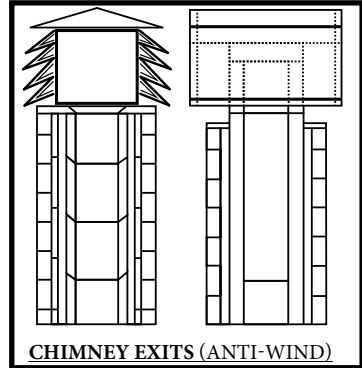

Chimney

The chimney or the duct component must conform with the following requirements: to be airtight, waterproof and properly insulated, to be constructed with materials resistant to the normal mechanical wear and to the heat coming from the combustion products and condensation.

- To be kept away from flammable materials.

The recommended chimney draft at work - from 12-20 Pa.

Attention!!! In case of a fire hazard turn off the product from the display. This will stop the oxygen flow to the product.

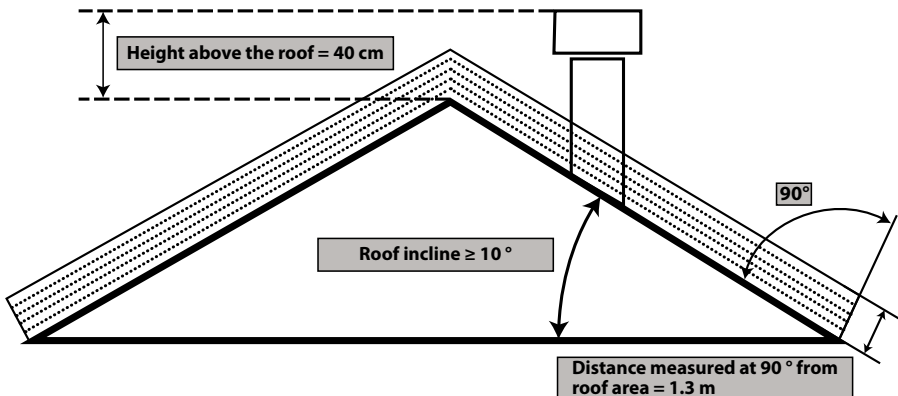

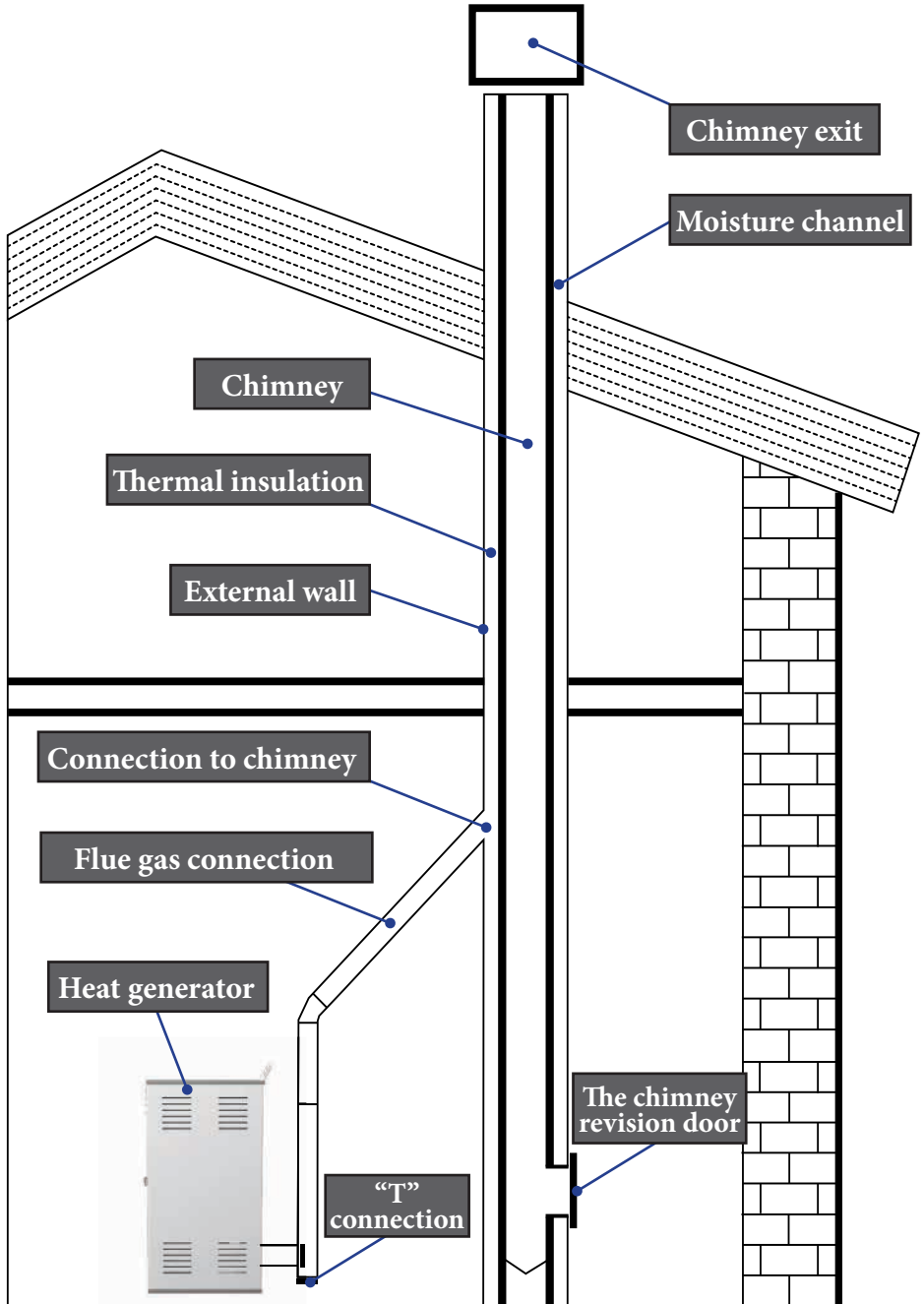

3.5 Air intake

Suction pipe or air intake is placed in the back and has a circular section with a diameter of 48 mm. The combustion air can be aspirated:

- From the camera, as long as it is near an air intake communicating with the outside wall having a minimum area of 100 cm², properly positioned and protected by a grid.
- Or by connecting directly outside with a suitable tubing having an inner diameter of 48 mm and a maximum length of 1.5 M.2

4. Cleaning

Cleaning the fireplace should be done only when cold. The cleaning of the combustion chamber must be carried out daily. For this purpose, make sure the fireplace has ceased operation and is completely cold. Pull up the combustion pot and remove it from the stove and then clean it from soot. When removed fuel pot at the bottom of the combustion chamber opens a hole designed for the accumulated ash. Collect ashes in the ashtray and return fuel pot in place and then close the door. The fireplace is ready for operation.

Cleaning of flues and chimneys are conducted once every 1.5 tons of fuel used

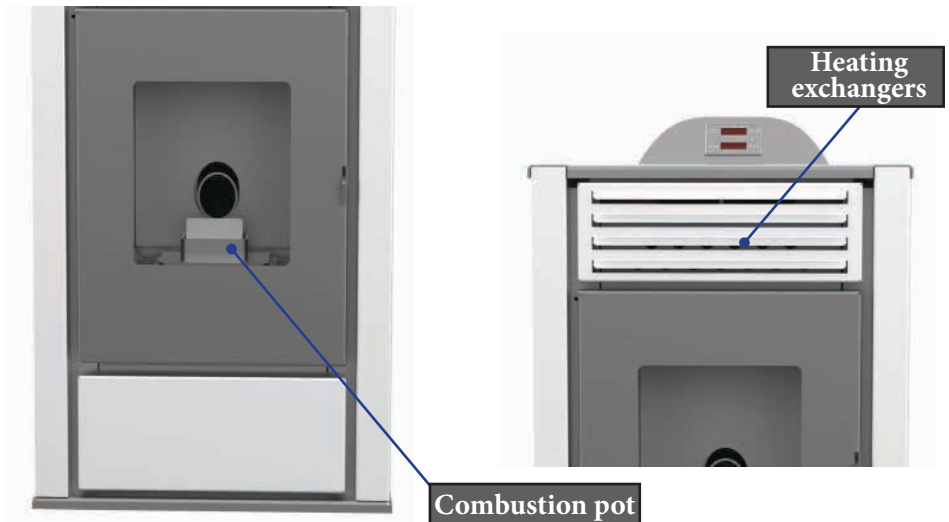

Once clean audits and close the cleaning lid. Check that the bolts are tightened well. Every time you open check for violations of the isolation seal. If this happens do not use the product until the isolation seal is repaired.

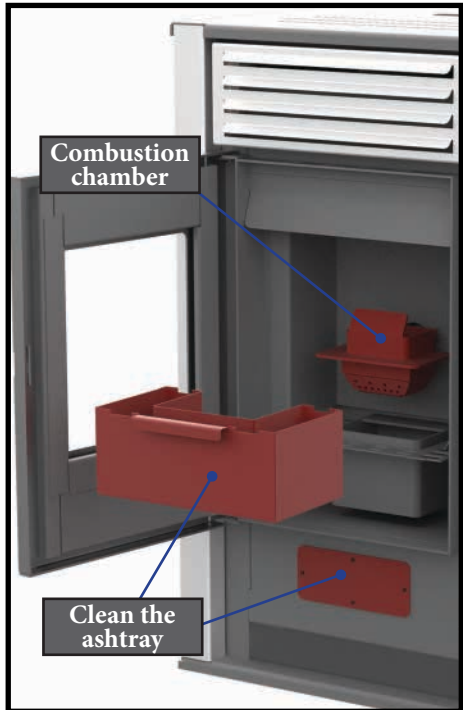
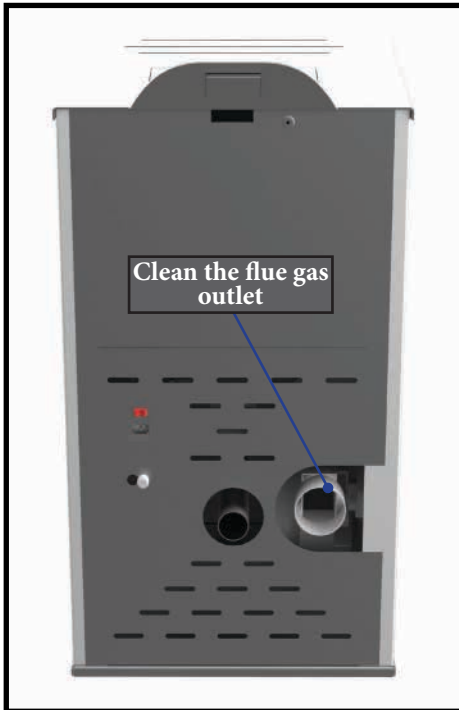
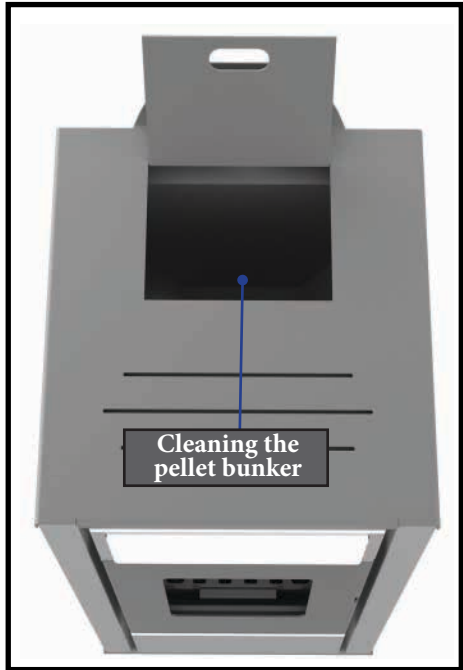

Maintenance program				
	At each ignition	Weekly	Twice per season	Annual
Combustion chamber	V			
Clean the ashtray		V		
Glass		V		
The Door		V		
Clean the flue gas outlet			V	V
Door seals				V
Chimney			V	V

5 Safety and unexpected risks

Terms of danger may arise in the following cases:

- Automated pellet stove is used incorrectly;
- The unit is installed by unqualified personnel;
- The safety instructions described in this management are not met;

Unforeseen risks:

Pellet fireplace “Mareli” has been designed and manufactured in accordance with the safety requirements on the national, regional and European levels. Although considered possible risks arising from improper use, you may experience the following risks:

- Risks of spreading combustion outside fireplace - opening the door of the chamber of the fireplace may fall hot / burning particles (as hot ash and small particles burning coal), which could lead to a fire in the heated room. It is therefore necessary that the product always works with a tightly closed door. It can only be opened when the product has completely cooled down;
- Risks of burns caused by high temperatures as a result of the combustion process in the combustion chamber and / or access to the door of this burn chamber when the product is not completely cool;

In case of fire hazard the product should be stopped by the controller and power supply until the cause of the problem is determined.

Control Panel: Use and Functions

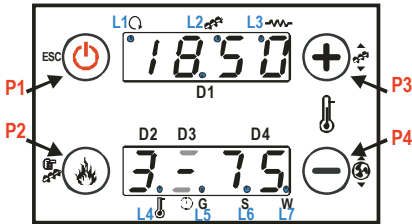

	KEY	CLICK	LONG PRESSURE
P1		Visualisations / Exit Menu	Ignition / Extinguishing / Block reset
P2		Combustion Power modify / Save data	Manual pellet loading
P3		Thermostat modify (+) / Increase data	Pellet loading correction
P4		Thermostat modify (-) / Decrease data	Combustion Fan speed correction

Values shown on the main frame

Display D1: time, system state, error, Menu, Submenu, parameter value; Display D2: power, parameter code; Display D3: recipe; Display D4: main temperature, parameter code.

L1		<u>Heating Fan On</u>
L2		<u>Auger On</u>
L3		<u>Ignition Resistance On</u>
L4		<u>Thermostat temperature reached</u>
L5		G <u>Daily program selected</u>
L6		S <u>Weekly program selected</u>
L7		W <u>Week End program selected</u>

ALARMS

Er01 - Security Error High Voltage 1. It may also intervene with the system off;
Er02 - Security Error High Voltage 2. It can only intervene if the Combustion fan is active;
Er03 - Extinguishing for low exhaust temperature or missing light in the brazier;
Er05 - Extinguishing due to high exhaust temperature;
Er06 - Pellet Thermostat open (flame return from the brazier);
Er07 - Encoder Error. The error may occur due to lack signal from Encoder;
Er08 - Encoder Error. The error can occur due to problems of adjustment of the number of revolutions;
Er11 - Clock Error. The error occurs due to problems with the internal clock;
Er12 - Extinguishing for ignition failure;
Er15 - Extinguishing due to power failure for more than 50 minutes;
Er17 - Adjusting the Air Flow Failed;
Er18 - No more Pellet in the bunker;
Er39 - Air Flow sensor damaged;
Er41 - Minimum air flow in Check Up is not reached;
Er42 - Maximum air flow exceeded (**F40**);
Er44 - Open door error;
Er47 - Error Encoder Auger: missing signal Encoder (if **P81**=1 or 2);
Er48 - Error Encoder Auger: Auger regulation speed not achieved (if **P81**=1 or 2);
Service - Service error. It notifies that the planned hours of functioning (parameter **T66**) is reached.
 It is necessary to call for service.

MESSAGES

Description	Code
Anomaly of the probes checking, during Check Up phase.	Sond
Room temperature greater than 50 °C.	Hi
This message notifies that the planned hours of functioning (parameter T67) are reached.	CLr
Door Open.	Port
The message appears if the system is turned off during Ignition (after Preload) not manually: the system will stop only when it goes in Run Mode.	OFF dEL
Periodical Cleaning in progress.	PCLr
No communication between motherboard and keyboard	-

USER MENU 1

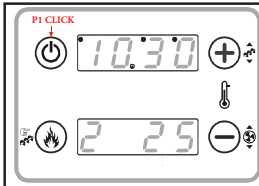

tA = Room Temperature [°C];
 tF = Exhaust Temperature [°C];
 tr = Remote Room temperature [°C];
 UF = Speed Combustion Fan [RPM];

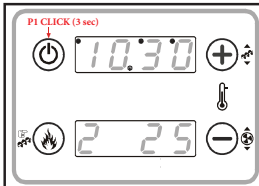

It is possible to activate the **ignition process** with long press on the **P1** button;
 It is possible to activate the **extinction process** with long press on the **P1** button;
 It is possible to clear the **Block** with long press on the **P1** button.

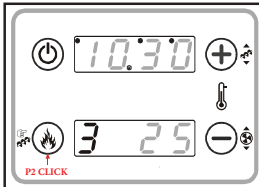

Combustion Power Setting

Click on **P2** button: the **D2** display blinks. With other click of the same button the power is changed. Ex.: 1-2-3-4-5-A (A=Automatic combustion). After 5 seconds the new value is saved and the display shows as normal.

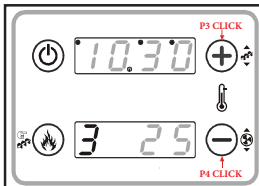

Thermostat Setting

Press the **P3** or **P4** key: the **D3** display blinks. With sequential clicks on the **P3 / P4** button, it is possible to increase or decrease the set temperature of the thermostat. After 5 seconds the new value is saved and the display shows as normal.

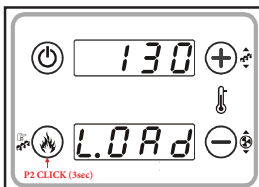

Manual Pellet Loading

The long pressure of button **P2** activates the Pellet Manual Loading with activation of Auger engine in continuous way. The bottom display shows the word **LoAd**, the up display shows the elapsed loading time. To stop the loading push any button. The loading stops automatically after 300 seconds.

	<p>Pellet Loading Correction</p> <p>The long pressure of P3 button activates this function (You have to do it two times to access the modify modality). The bottom display shows PELL, the upper display the value. With buttons P3/P4 the value is increased or decreased; the default set is '0'. After 5 seconds the new value is saved and the display shows as normal.</p>
--	---

	<p>Combustion Fan Correction</p> <p>The long pressure of P4 button activates this function (You have to do it two times to access the modify modality). The bottom display shows UEnt, the upper display the value. With buttons P3/P4 the value is increased or decreased; the default set is '0'. After 5 seconds the new value is saved and the display shows as normal.</p>
--	---

USER MENU 2

The access to the menu is done by pressing **P2** and **P4** at the same time.

<p>Heating Power (Air)</p>	<p>This menu allows to change the heating power:</p> <ul style="list-style-type: none"> • Power manually set from 1 to 5. • Heating Power set automatic by the system.
-----------------------------------	--

	<p>Chrono Enable Menu</p> <p>This menu allows to select the chrono modality. On display appears the label ModE.</p>
--	---

MODALITY	LED
Gior: Daily Program , 3 programs for each day of the week;	
SEtt: Weekly Program , 3 programs for all days of the week;	
FISE: Week-End Program , 3 programs for Mon-Fri and Sat-Sun;	
OFF: Programs Disabled;	

MENU FOR PROGRAMMING TIME RANGES

On display appears the label **ProG**. It has 3 submenus, one for each program modality:

Daily: it allows to set 3 programs for each day of the week **Mo**;

Weekly: it allows to set 3 programs for all days of the week **MS**;

Week-End: it allows to set 3 programs for Mon-Fri and 3 programs for Sat-Sun **MF - SS**;

Instructions - For each program, it is necessary to set the time on and the time off.

- 1) Scroll with the buttons **P3/P4** until the wished Submenu and push the button **P3 (Gior n)**;
- 2) Push the buttons **P3/P4** to select one of the 3 available programs;
- 3) Push the button **P1** for 3 seconds;
- 4) Select the ignition time;
- 5) Push the button **P2** to enter in modify mode: the selected value (hours or minutes) blinks. Push the button **P3** to switch between hours and minutes, **P3/P4** to modify the value;
- 6) Push the button **P2** to save;
- 7) Select with the button **P3** the Off Timer and repeat the procedure from point 5;

For each time is possible to modify minutes with intervals of 15 minutes (e.g.: 20:00, 20:15, 20:30, 20:45).

Only for 11 p.m. is possible to increase minutes from 45 to 59, in order to get an ignition around midnight.

	<p>Using the P3/P4 buttons is possible to view all programs:</p> <ul style="list-style-type: none"> • The top of the display shows programs; • No Programs is shown with (- - -); • The bottom of the display shows: day / time zone / start / stop; <p>Continuously pressing button P1 is possible to switch on / off the selected time.</p>
--	--

	<p>Program Chrono across Midnight (00:00)</p> <p>Set the ON time of the previous day to the desired value: Ex. 20h30; Set the OFF time of the previous day: 23h59 Set the hour of the next day 00h00;</p> <p>Set OFF time the next day: Ex. 6h30. The system turns ON at 20:30 from Tuesday to Wednesday and turns OFF at 06:30.</p>
--	---

Clock (oroL) - This Menu allows to set time and date. The above display shows hour and minutes, the under display shows the day of the week. Push the button **P2** to enter editing. The selected value (hours, minutes, days) blinks. To change the value use the **P3/P4** button. Push the button **P2** to switch to modify the other parameters. Push again **P2** to save the set value.

Ducting Power (Can)	<p>It allows changing the Ducted Fan power:</p> <ul style="list-style-type: none"> • Power manually set from 1 to 5. • Heating Power set automatic by the system.
----------------------------	---

Remote room thermostat (rEM)	<p>This menu allows to modify the value of the Remote Room Thermostat, it is visible only if one input is configured as remote room probe and is P69 > 0.</p>
-------------------------------------	--

Selector Menu (SEL)	<p>This menu allows to manage the position of the Selector and change the heating air flow direction.</p> <p>LoC - Air Flow in the room where is the stove. rEM - Air Flow in the remote room.</p>
----------------------------	---

FUNCTIONING STATE VISUALIZATION

State	Code	State	Code	State	Code
Off	-	Ignition-Variable ignition	On 4	Safety	SAF
Check Up	ChEc	Stabilization	On 5	Extinguishing	OFF
Ignition-Pre-heating	On 1	Run mode	-	Block	AIt
Ignition-Preload	On 2	Modulation	Mod	Ignition Recovery	rEc
Ignition-Fixed ignition	On 3	Standby	Stby		

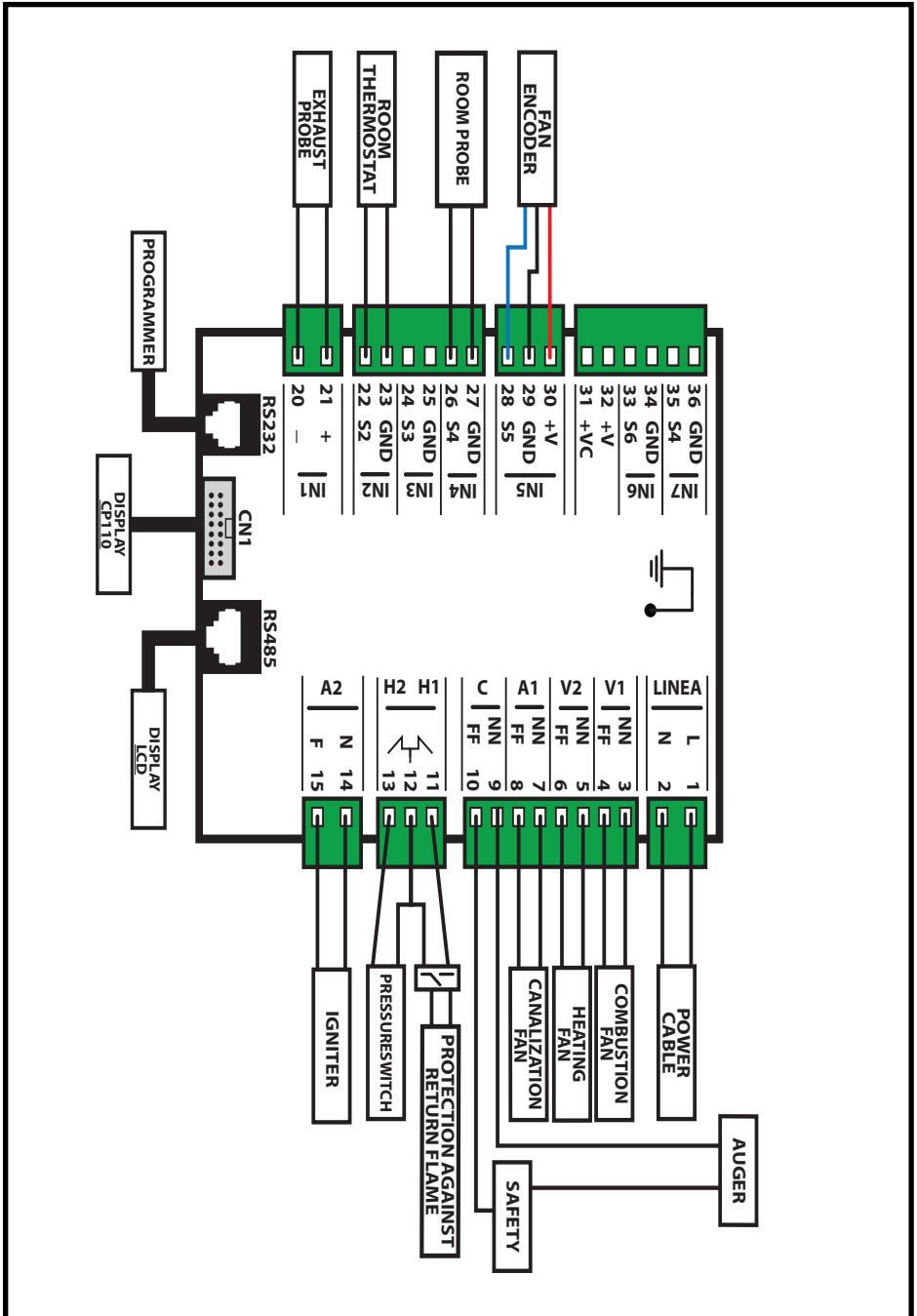

Mareli Systems

Mareli Systems

Industrial Zone
Simitli, 2730
Region Blagoevgrad
Bulgaria

info@mareli-systems.com
www.mareli-systems.com

MARELI SYSTEMS disclaims any responsibility for possible inaccuracies contained in this manual if they are due to printing or transcription errors. We reserve the right to make any change that appears to be necessary or useful without harm the essential characteristics.
